

Towards a VLSI Design Flow Based on Logic Computation and Signal Distribution

André Reis

“Usual” Flow

- To be taken with care, but:
 - Separate teams
 - Separate cultures
 - Separate conferences
 - IWLS/ISPD

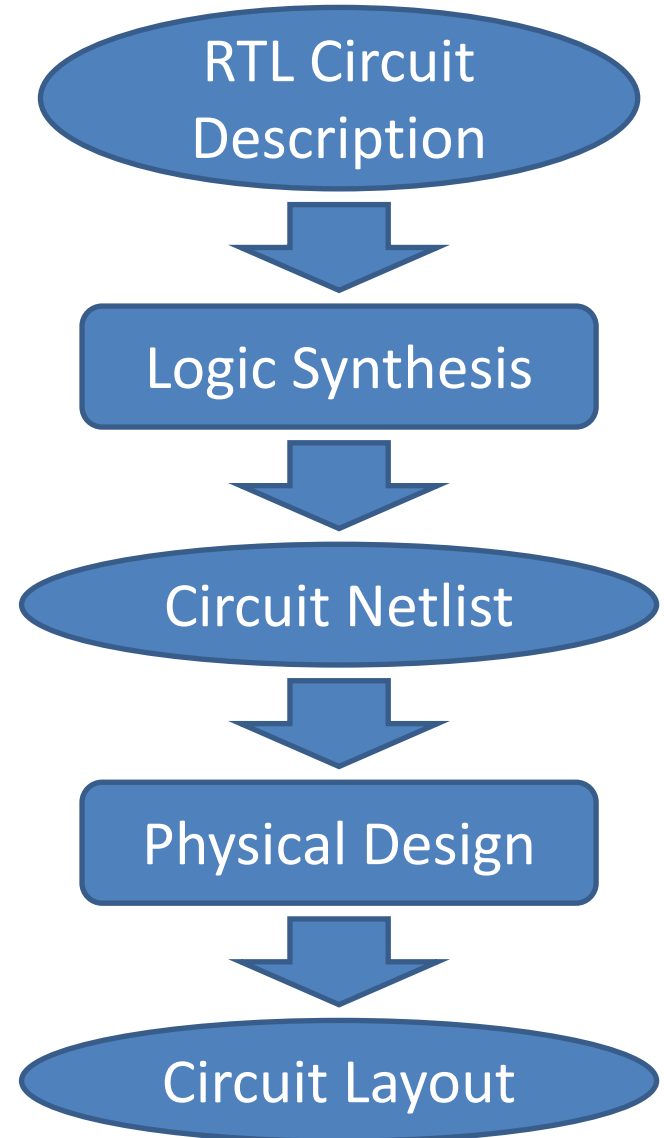

Logic Synthesis: AIG And-Inverter-Graph

- Set of interconnected nodes

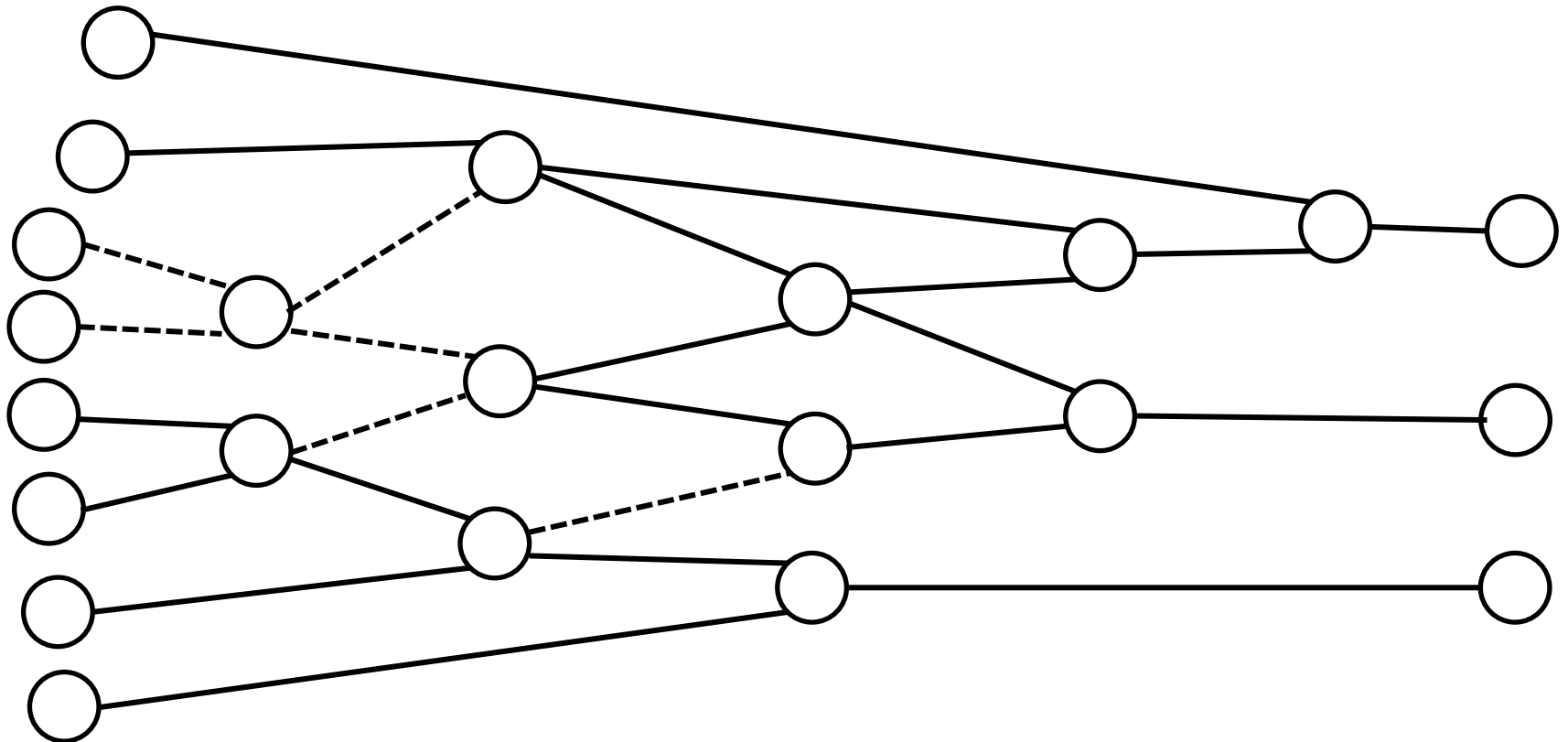

Logic Synthesis vs. Physical Design

- AIG
- Implicit inverters
- Cuts
- Netlist
- Explicit inverter
- Partitioning

Design constraints: Late arrival times

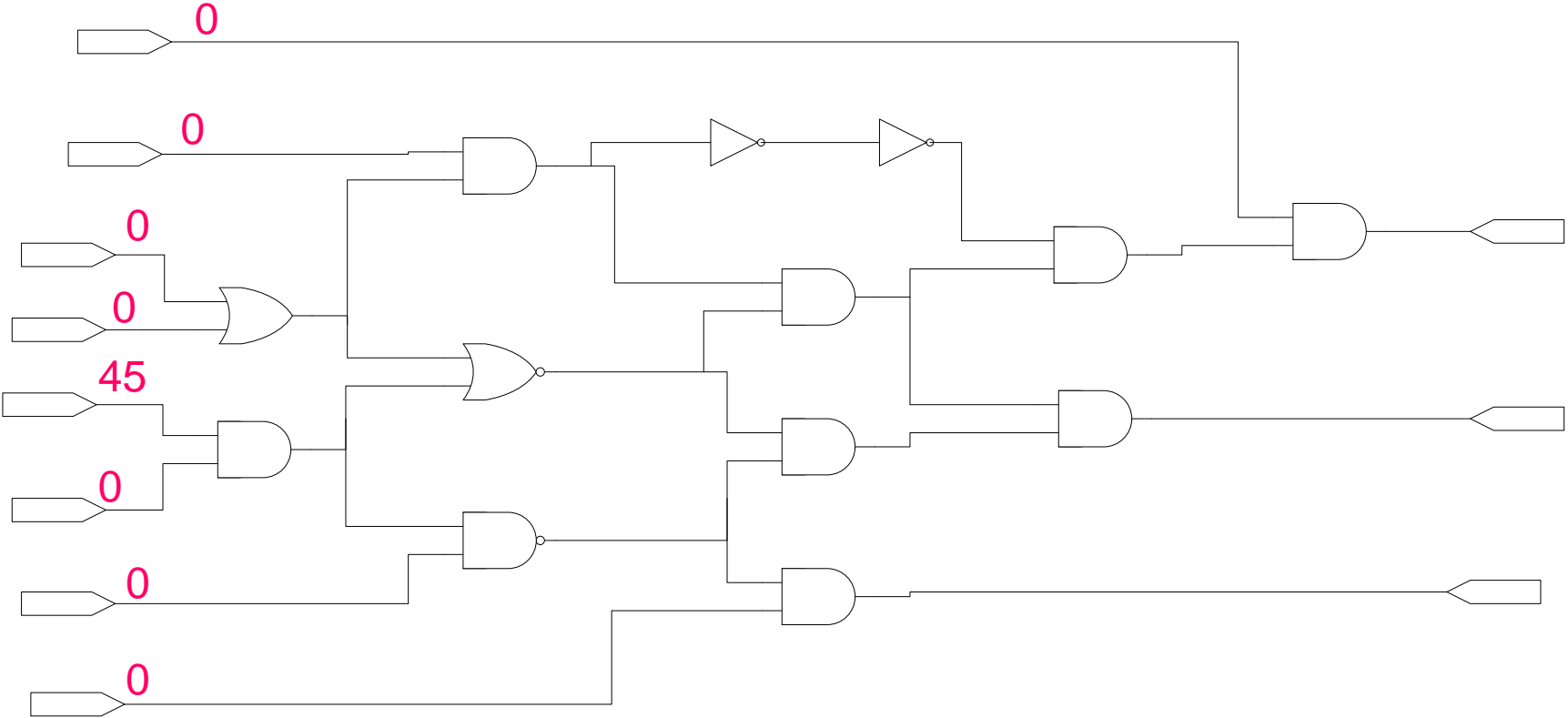

Design constraints: Early request

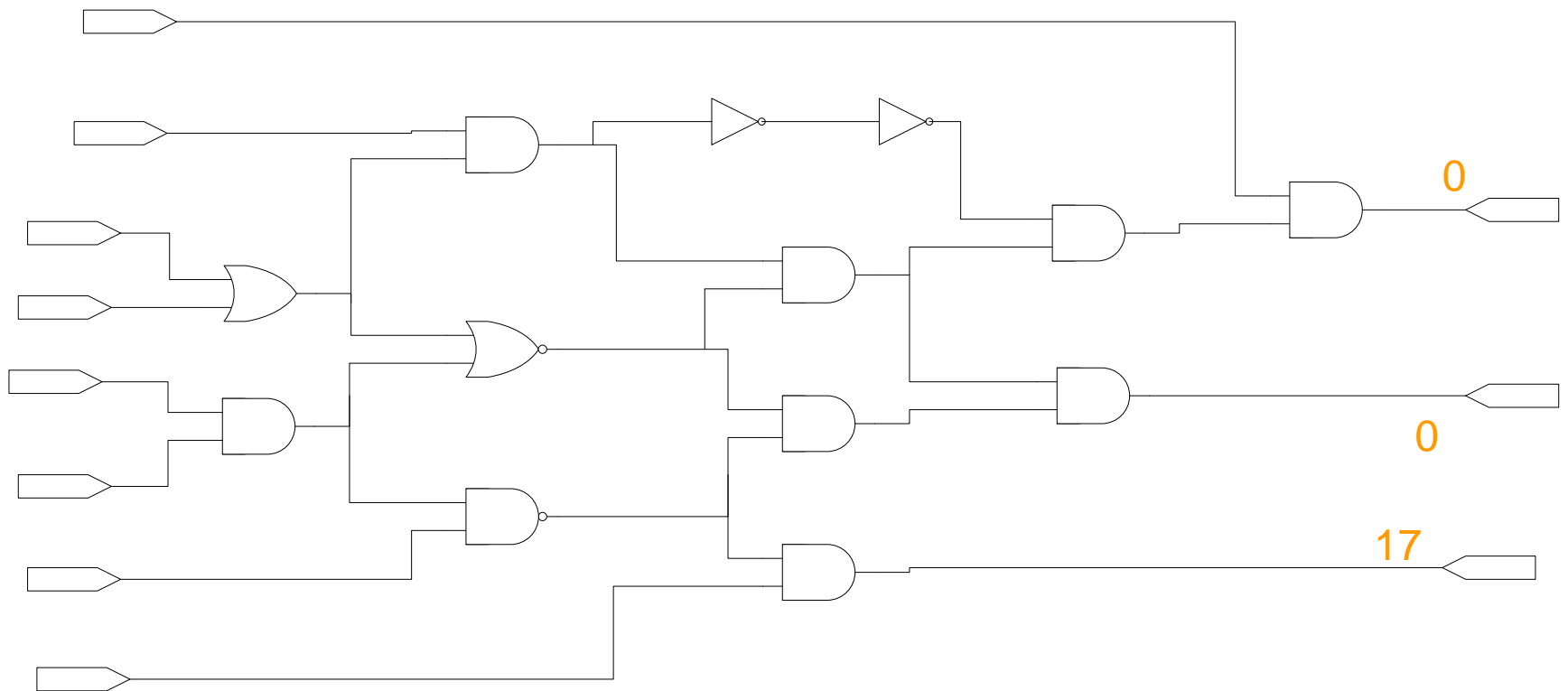

Backward delay

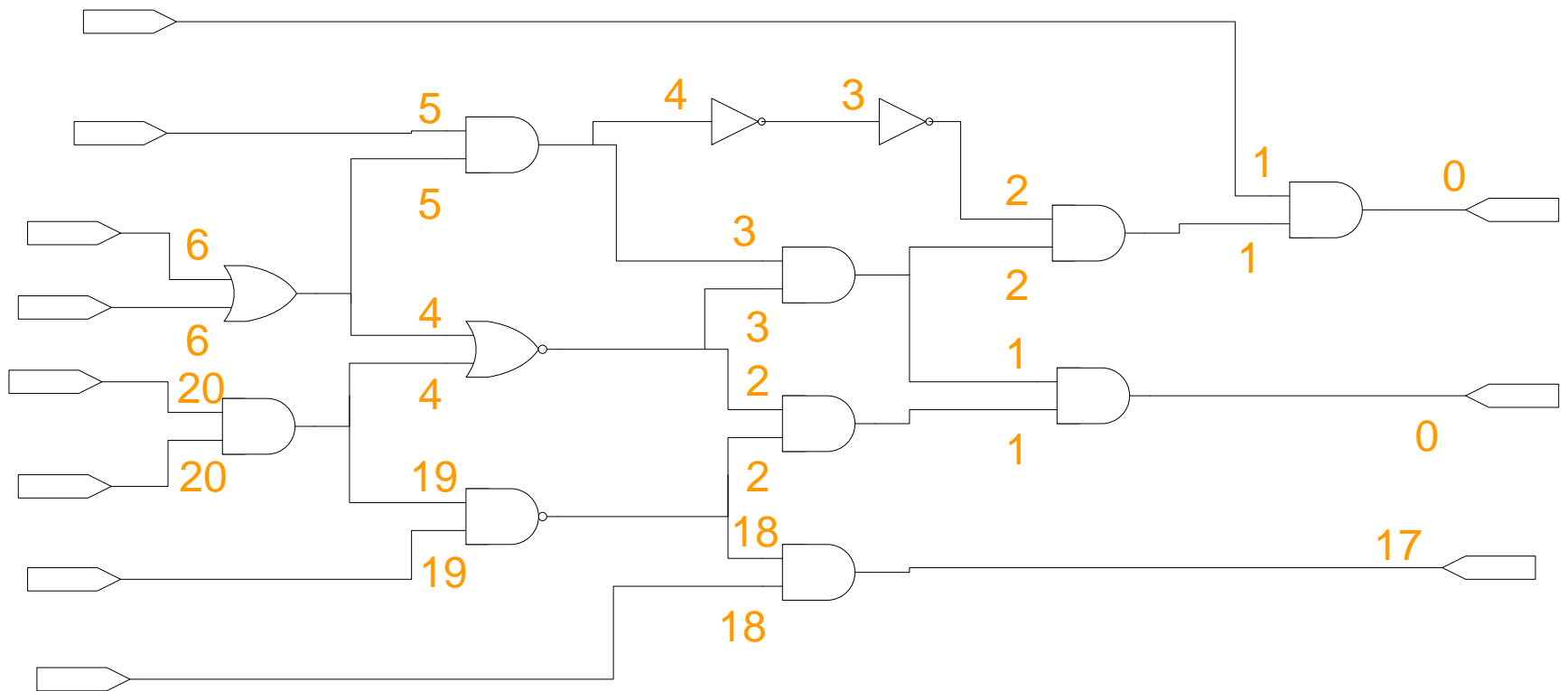

Design Constraints: Target Frequency

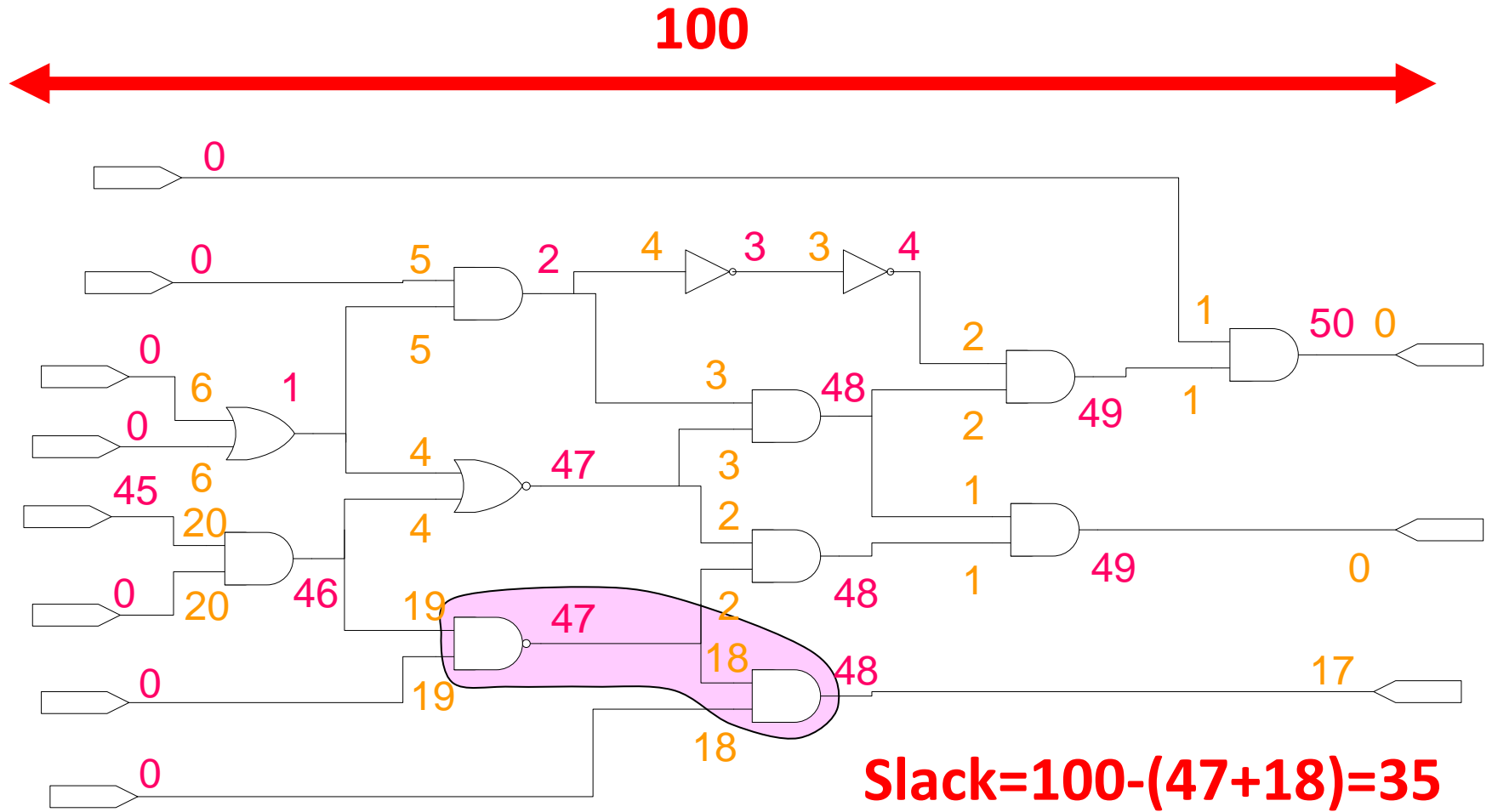

Design Constraints: Target Frequency

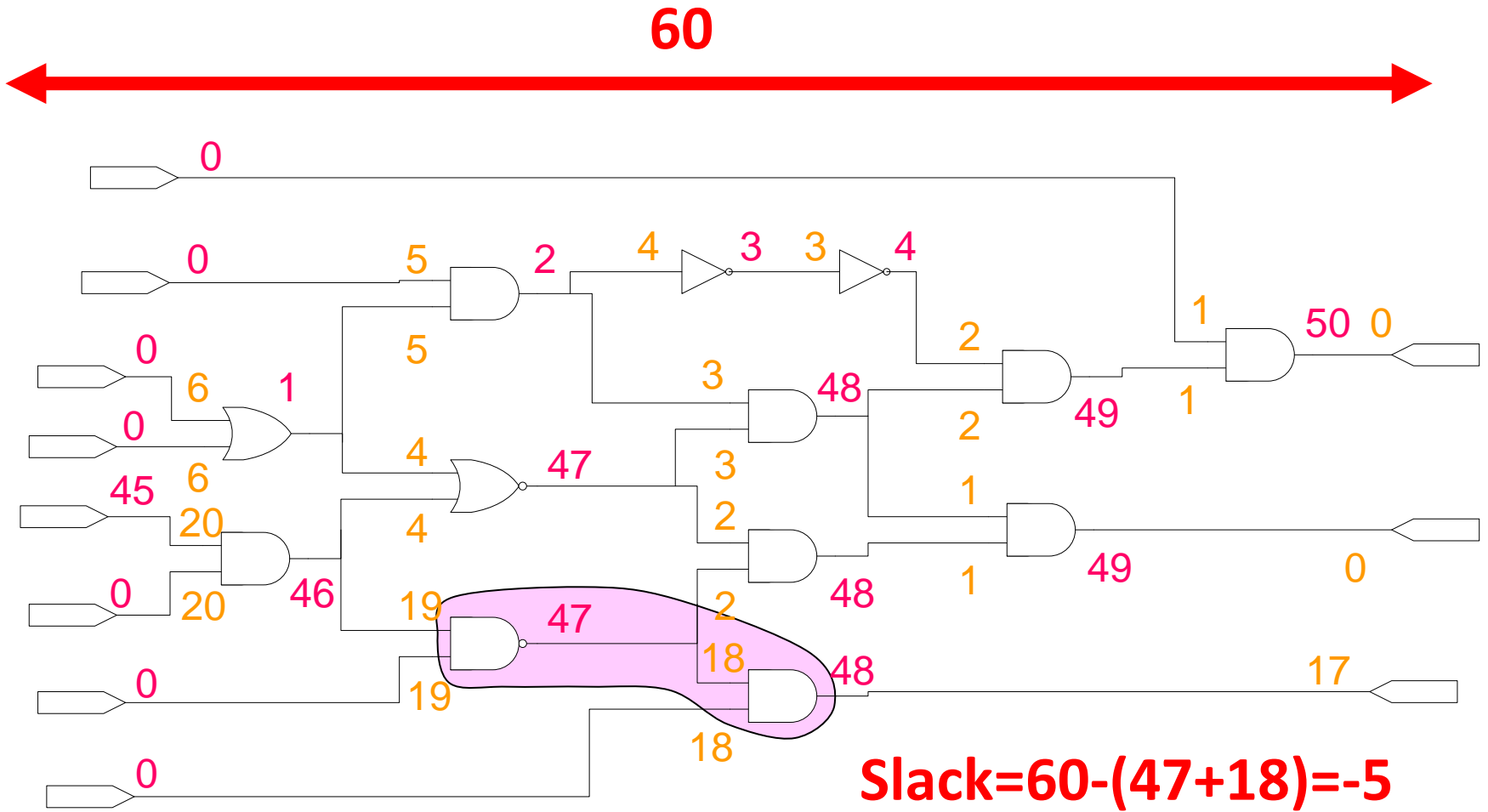

Design Constraints: Timing Budget

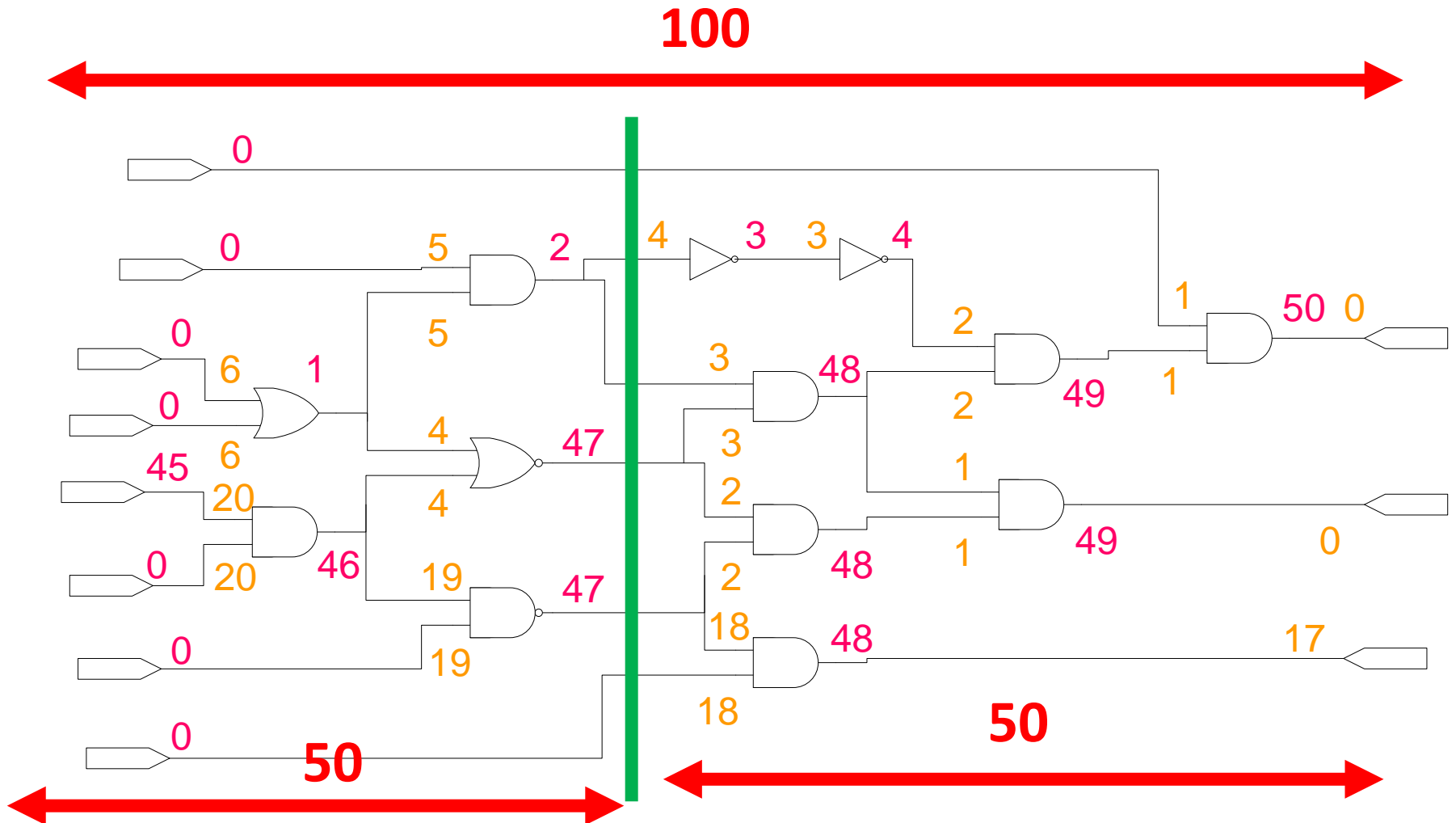

Design Constraints: Timing Budget

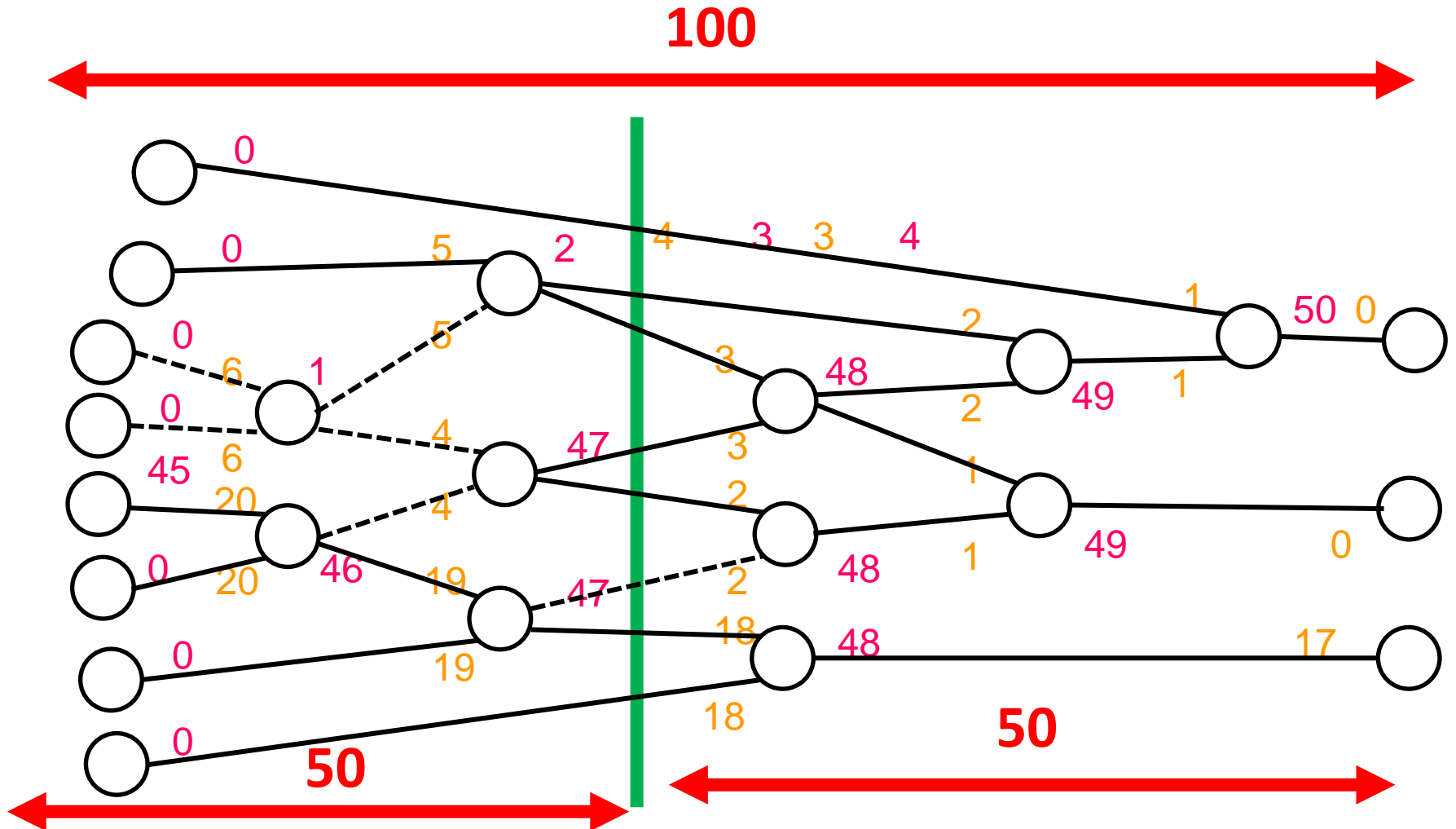

KL-cuts in AIGs

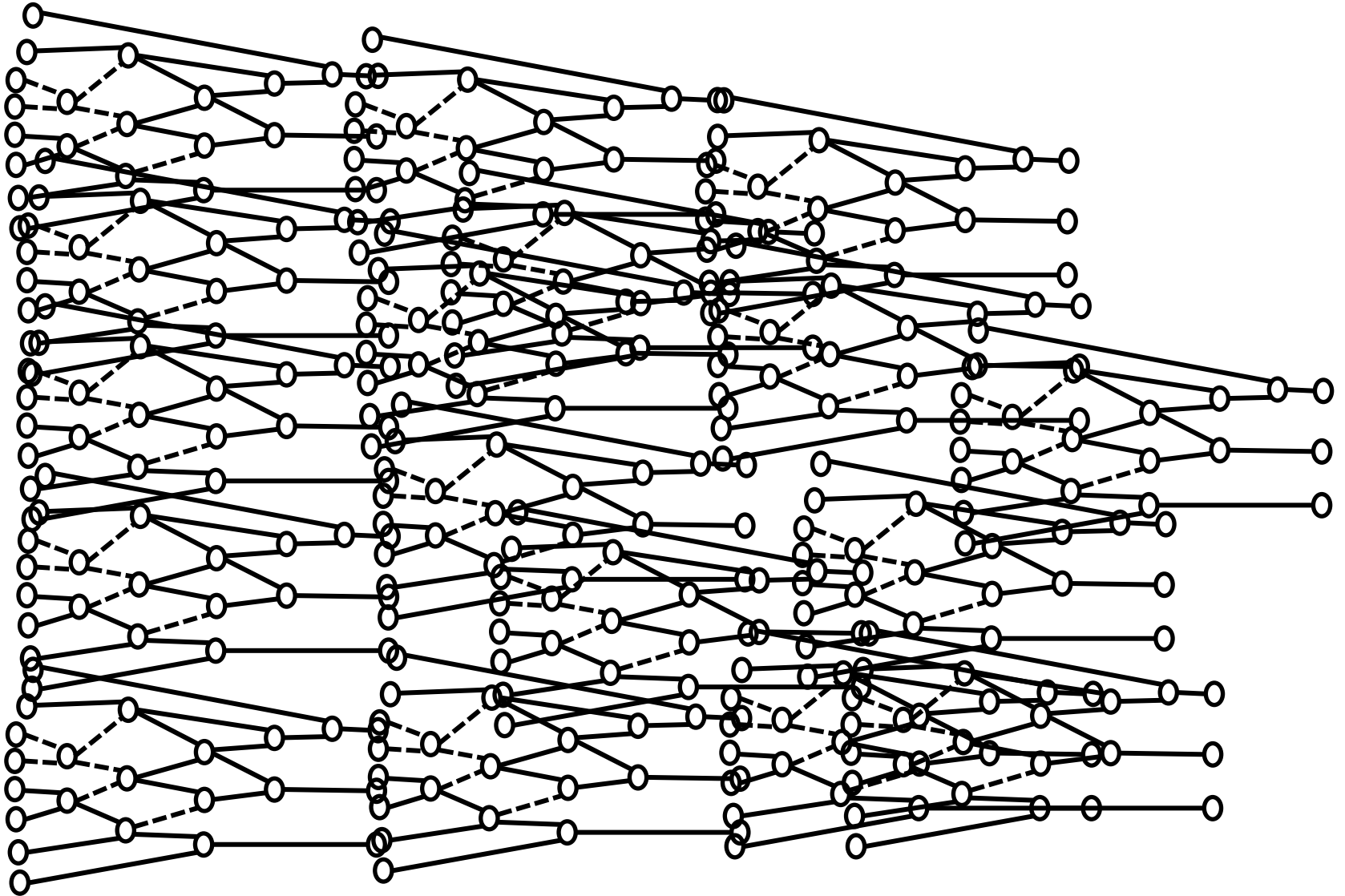

KL-cuts in AIGs

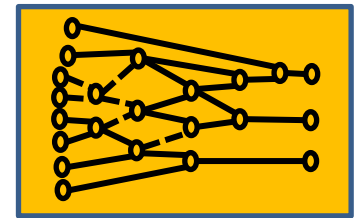
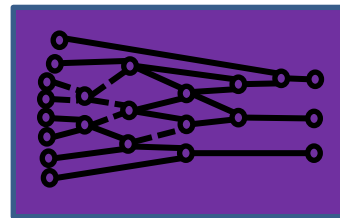
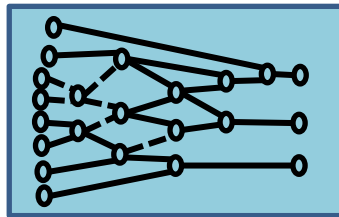
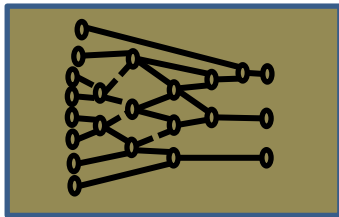
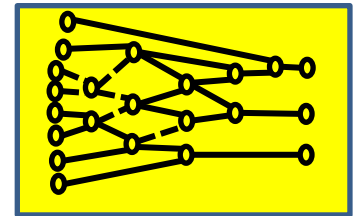
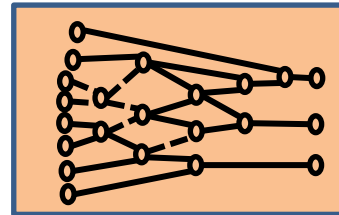
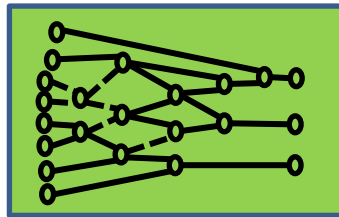
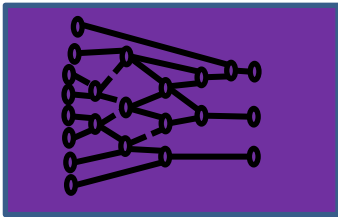
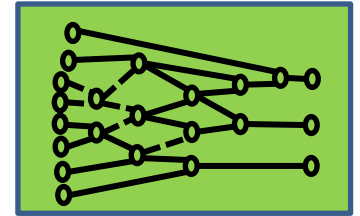
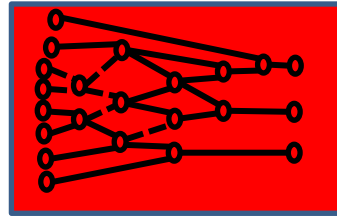
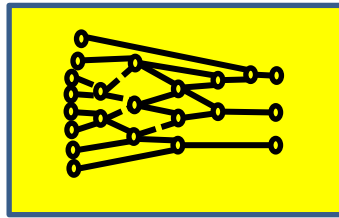
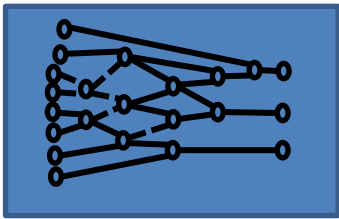

KL-cuts in AIGs

100

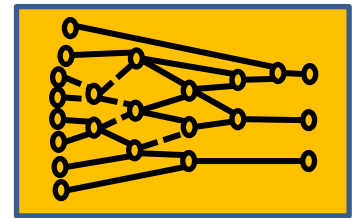
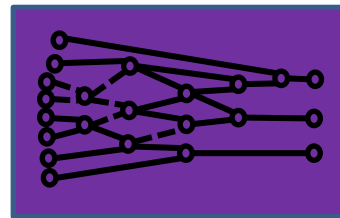
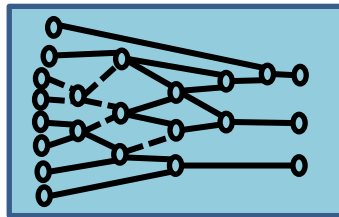
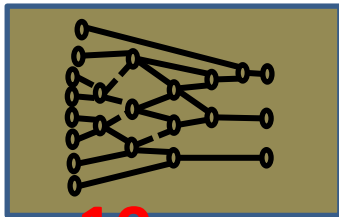
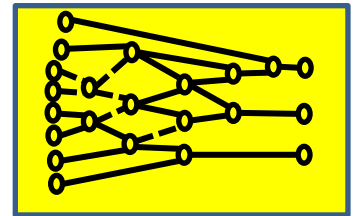
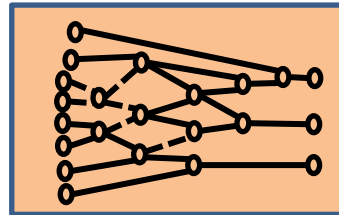
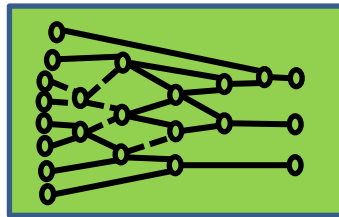
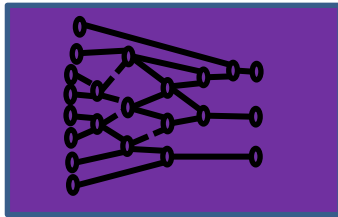
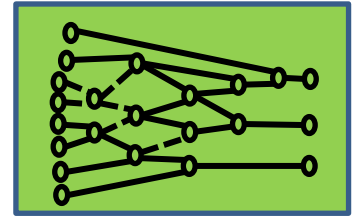
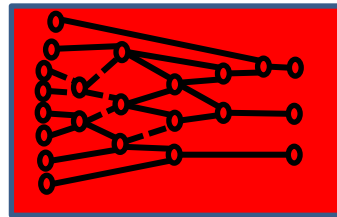
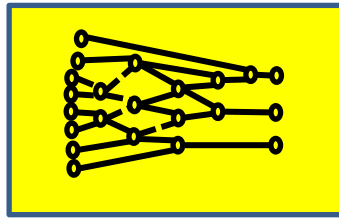
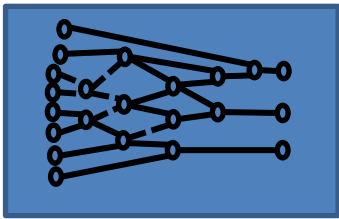

10



KL-cuts in AIGs

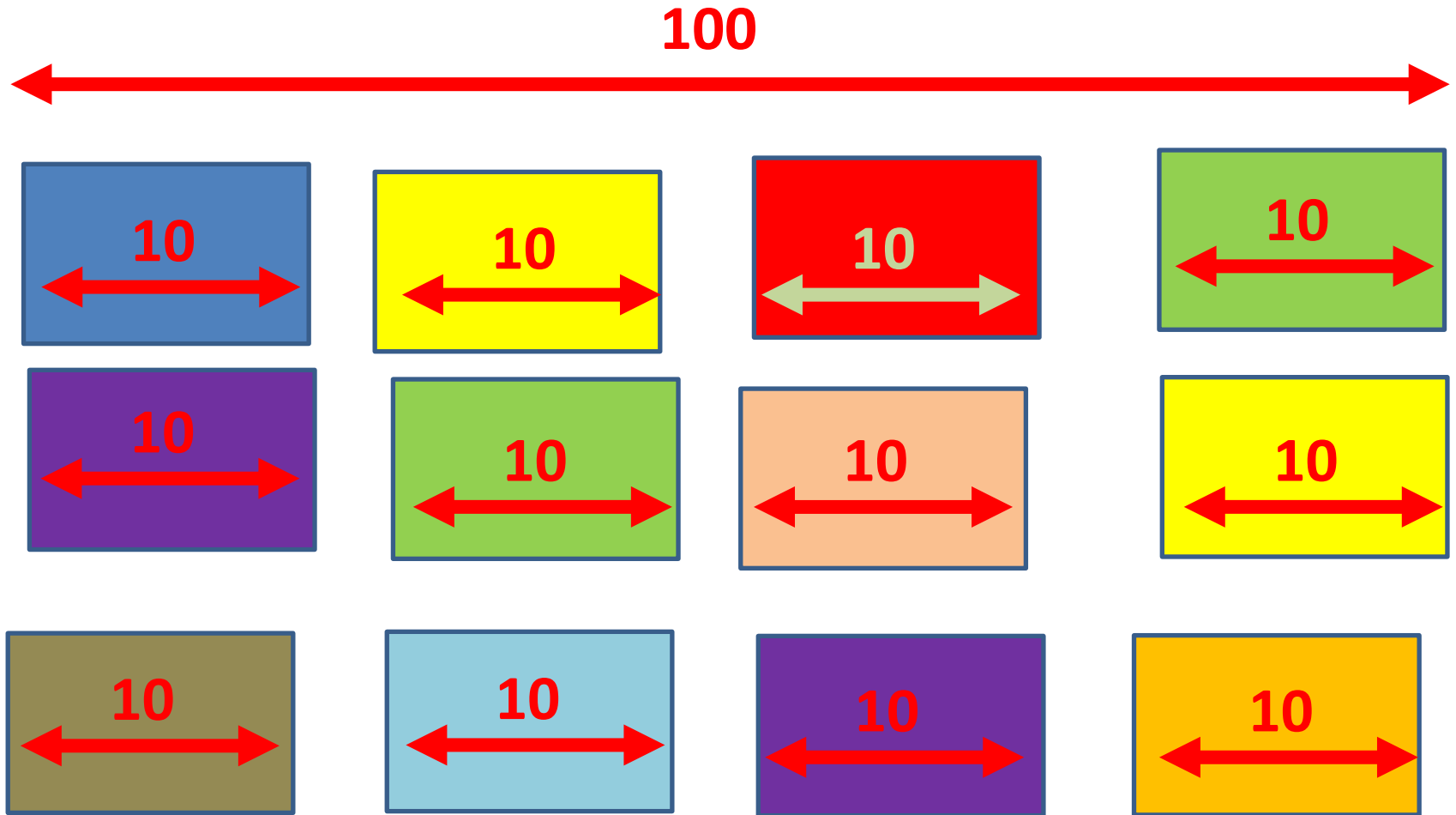

KL-cuts in AIGs: Signal Distribution

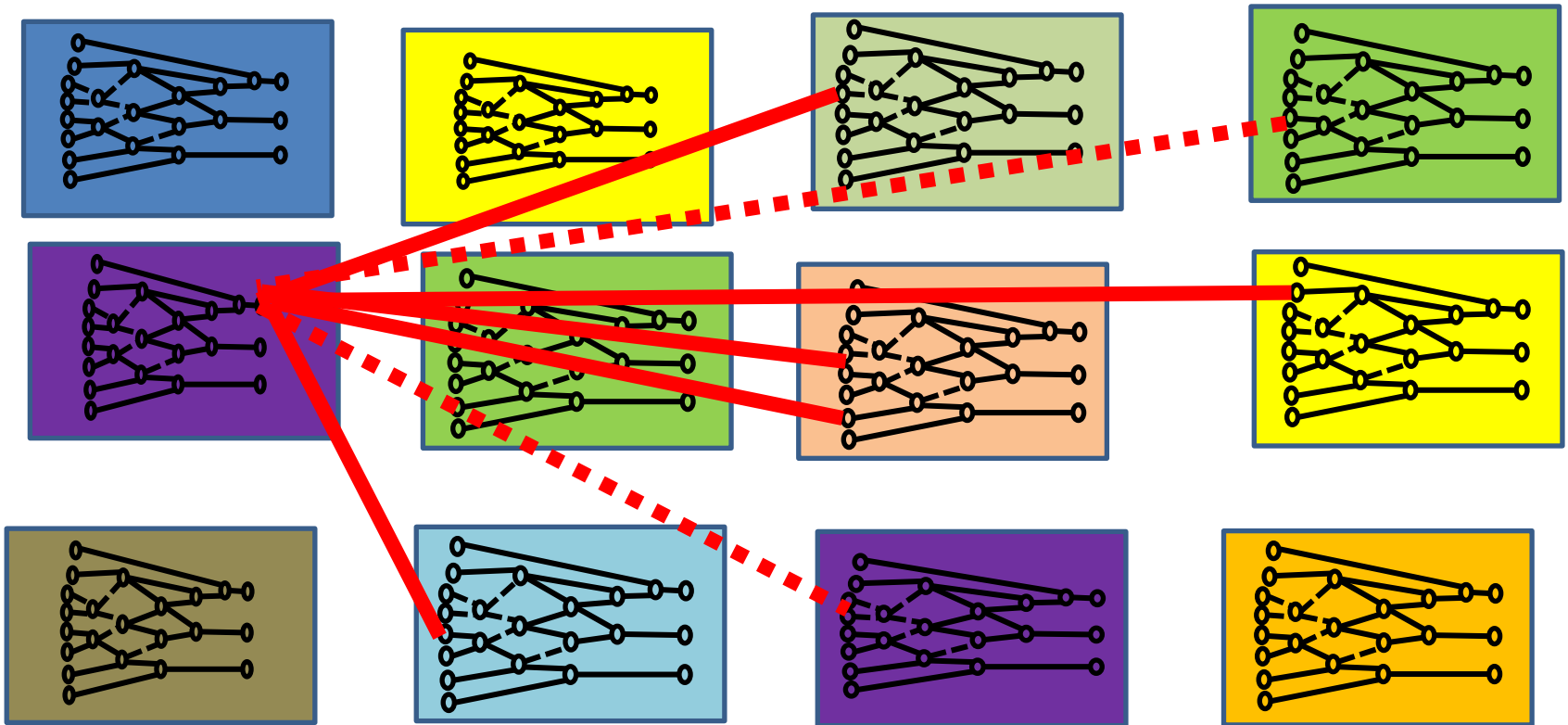

KL-cuts in AIGs

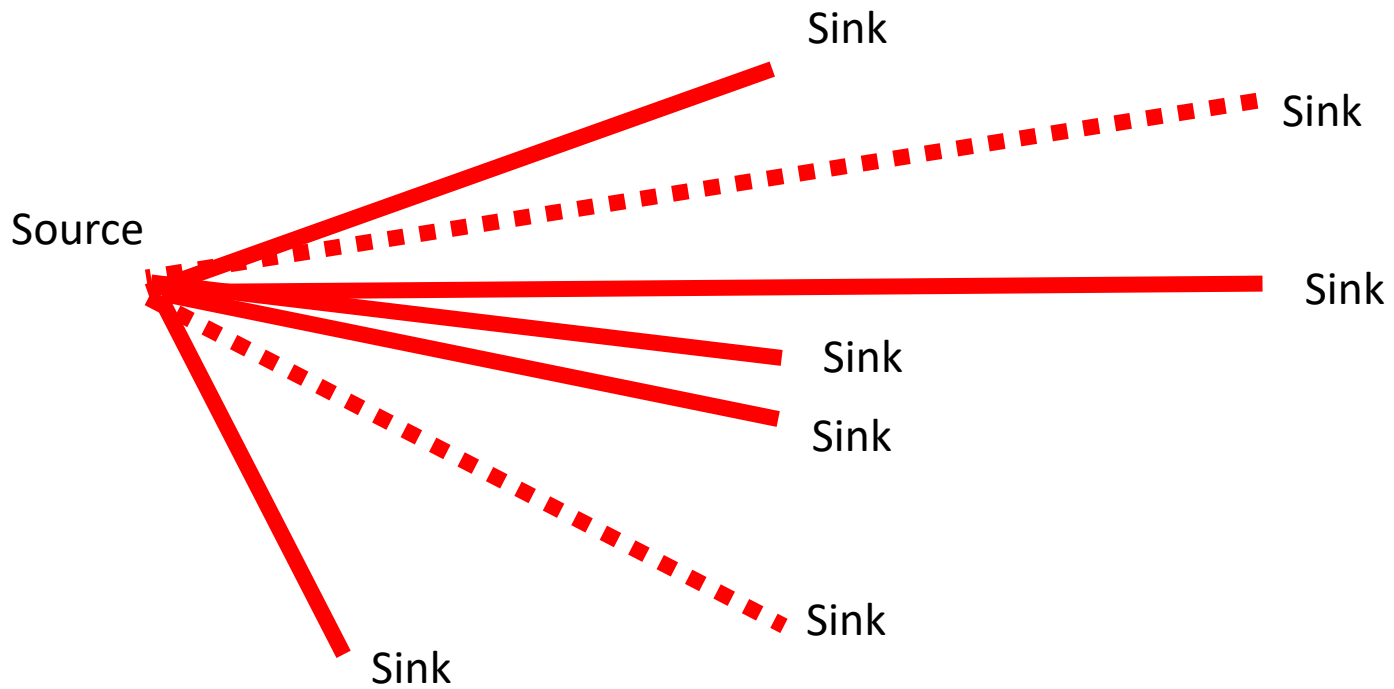

KL-cuts in AIGs

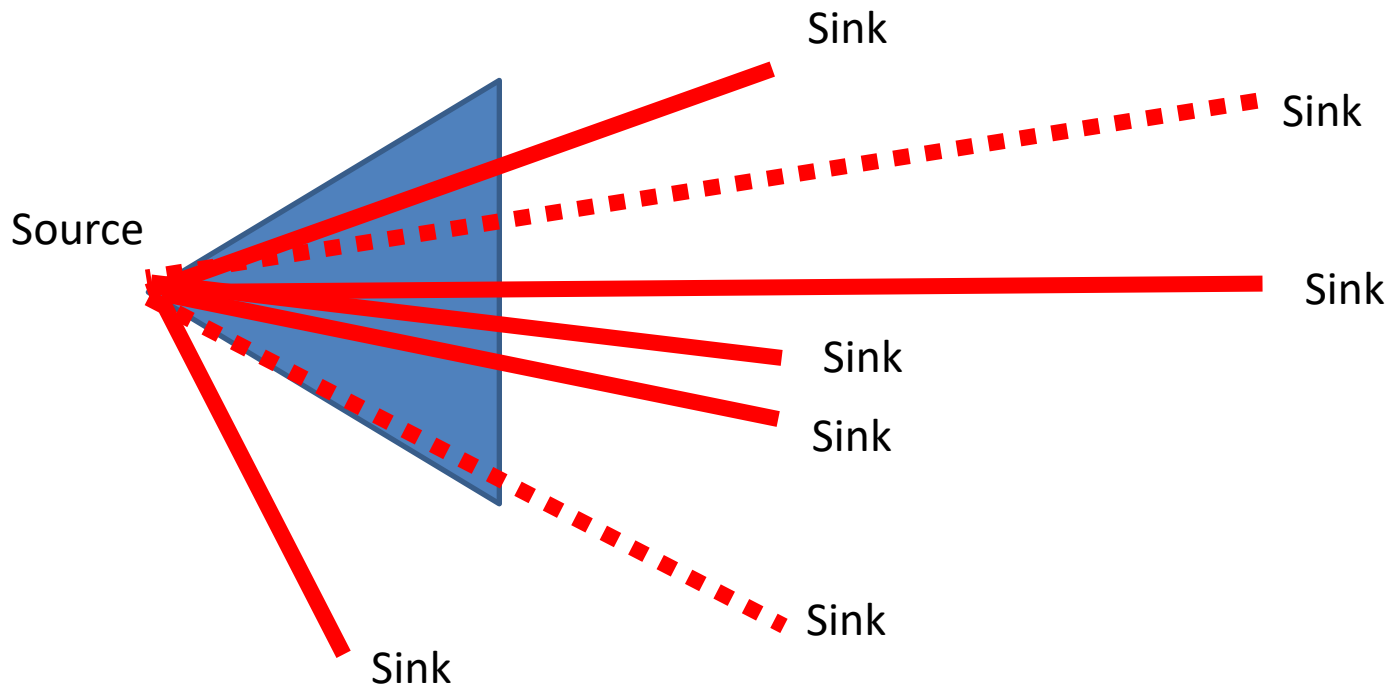

Signal distribution 1L-cuts in AIGs

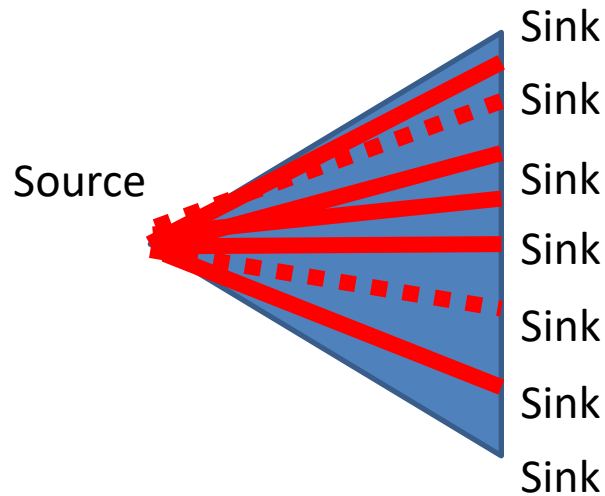

KL-cuts in AIGs

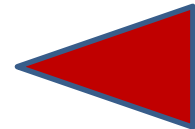
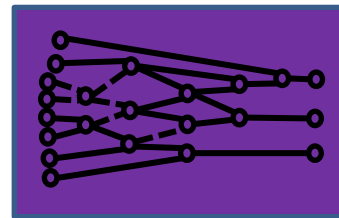
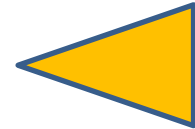
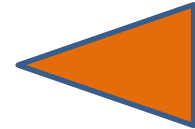
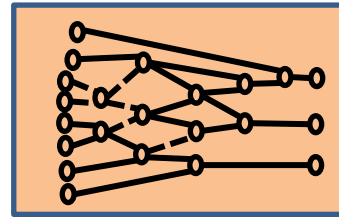
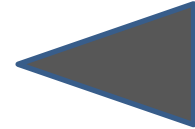
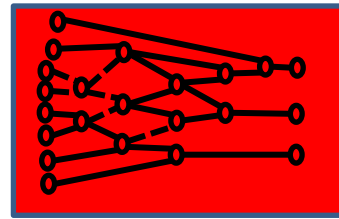
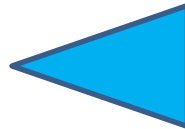
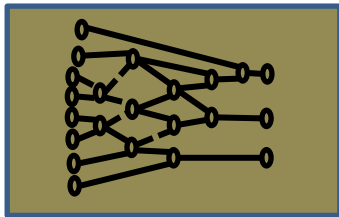
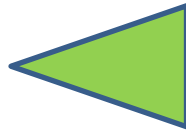
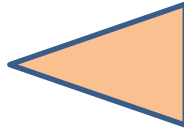
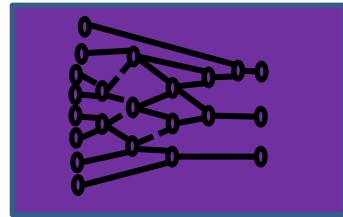
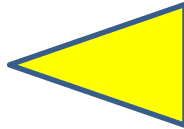
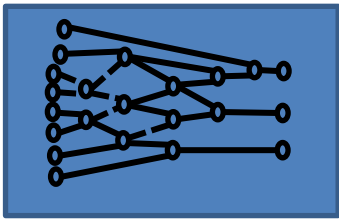

Logic Computation KL-cuts in AIGs

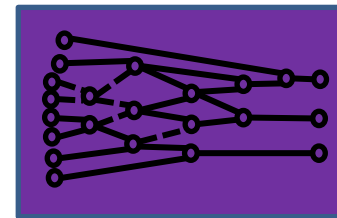
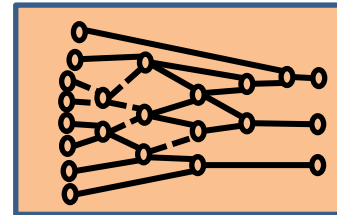
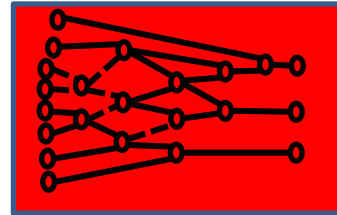
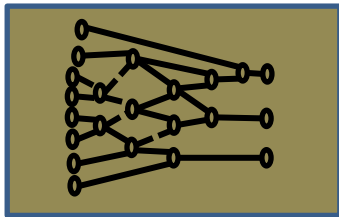
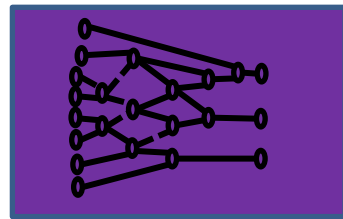
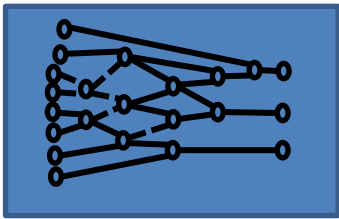

Signal Distribution 1L-cuts in AIGs

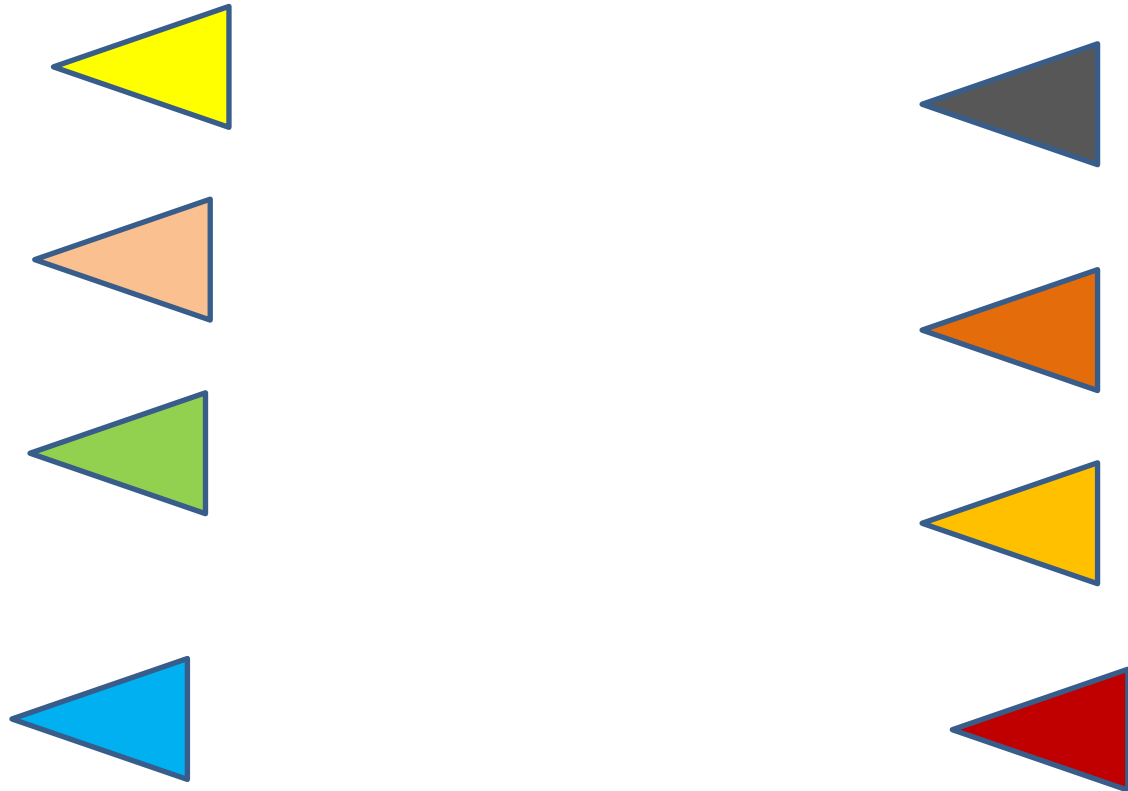

What about a design flow?

- This talk was supposed to bring technology information on early steps of logic synthesis!!!!

Step 1: Receive Input AIG

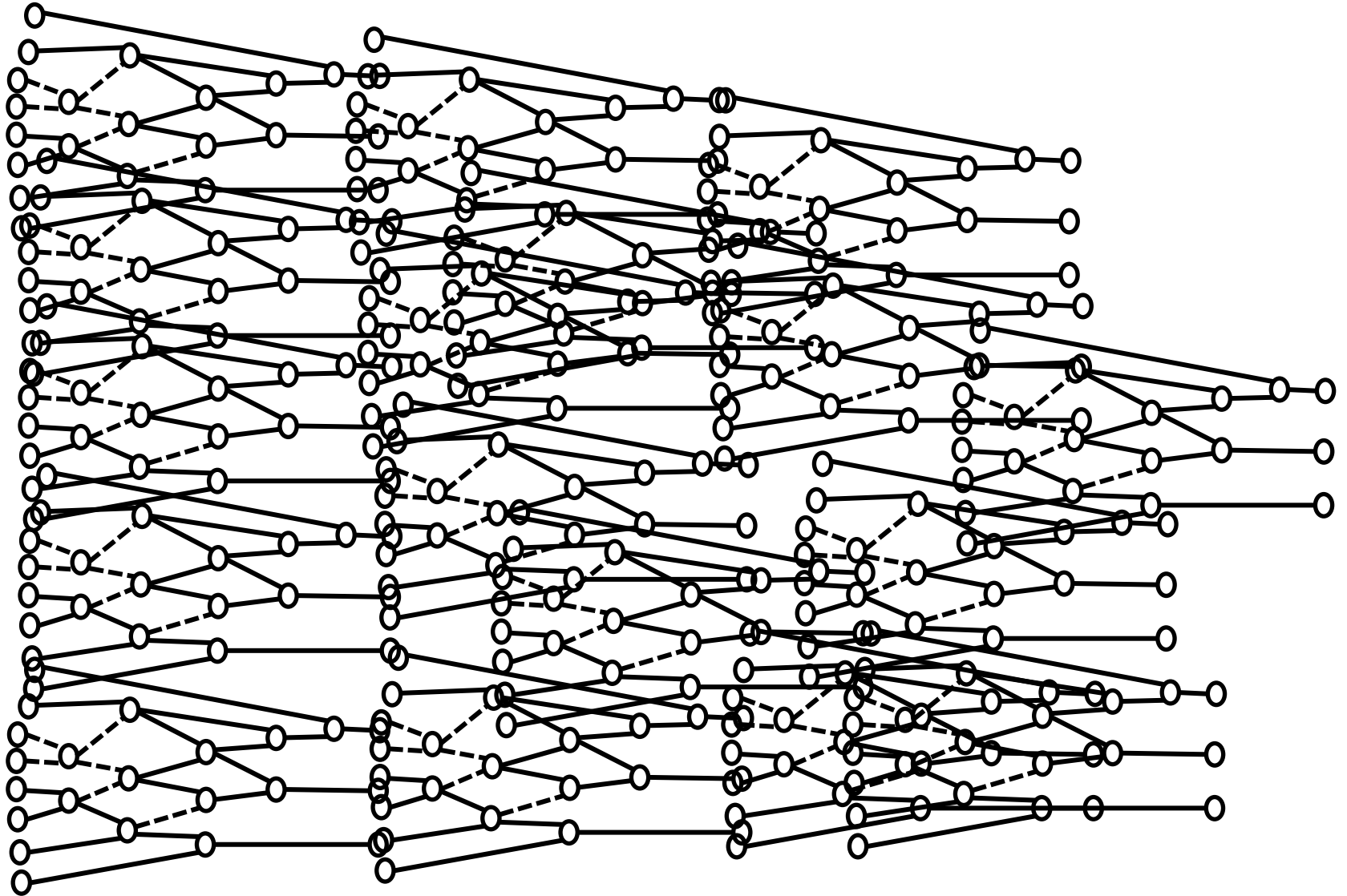

Step 2: Compute KL-cuts

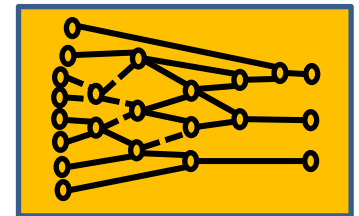
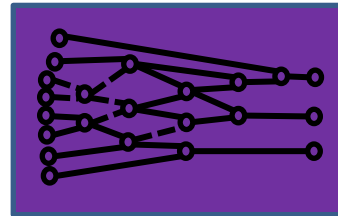
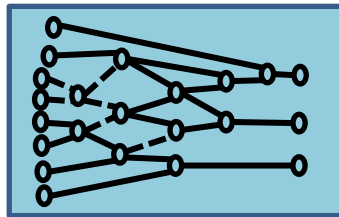
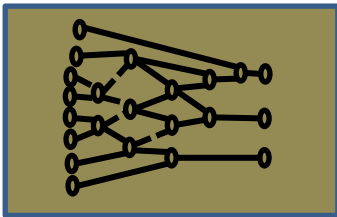
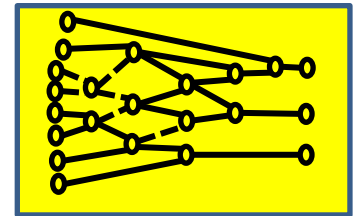
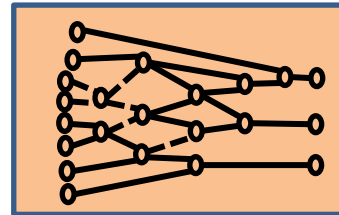
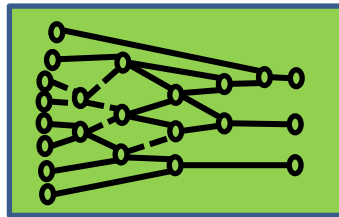
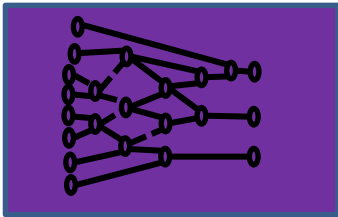
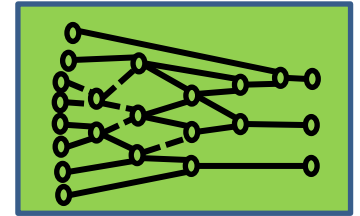
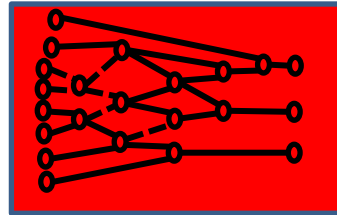
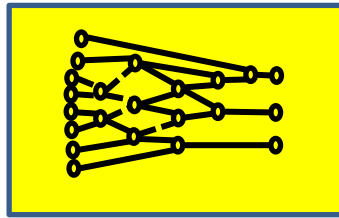
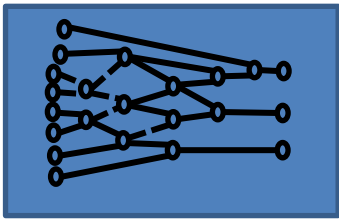

Step 3: Timing budget KL-cuts

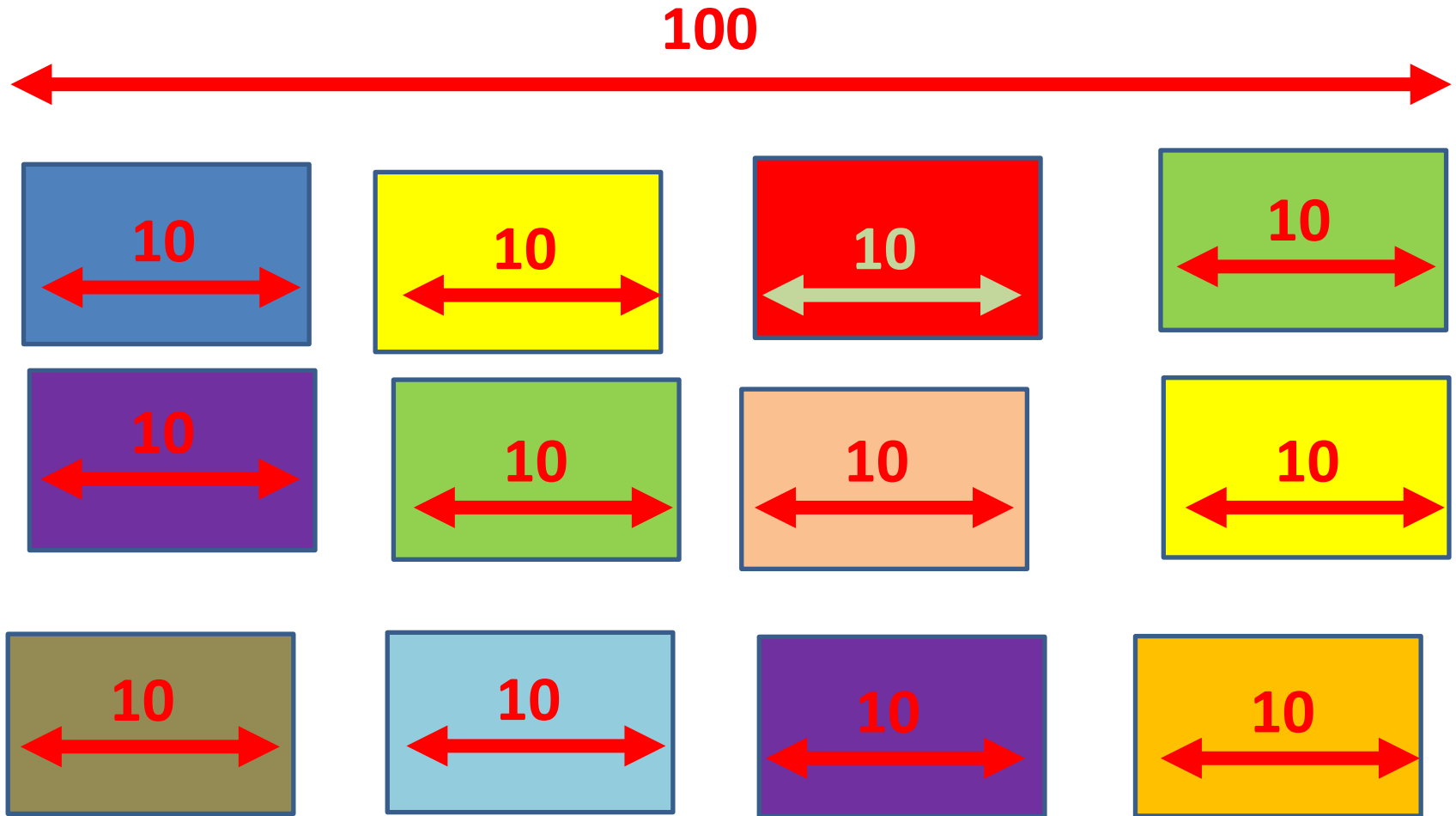

Step 4: Place KL-cuts

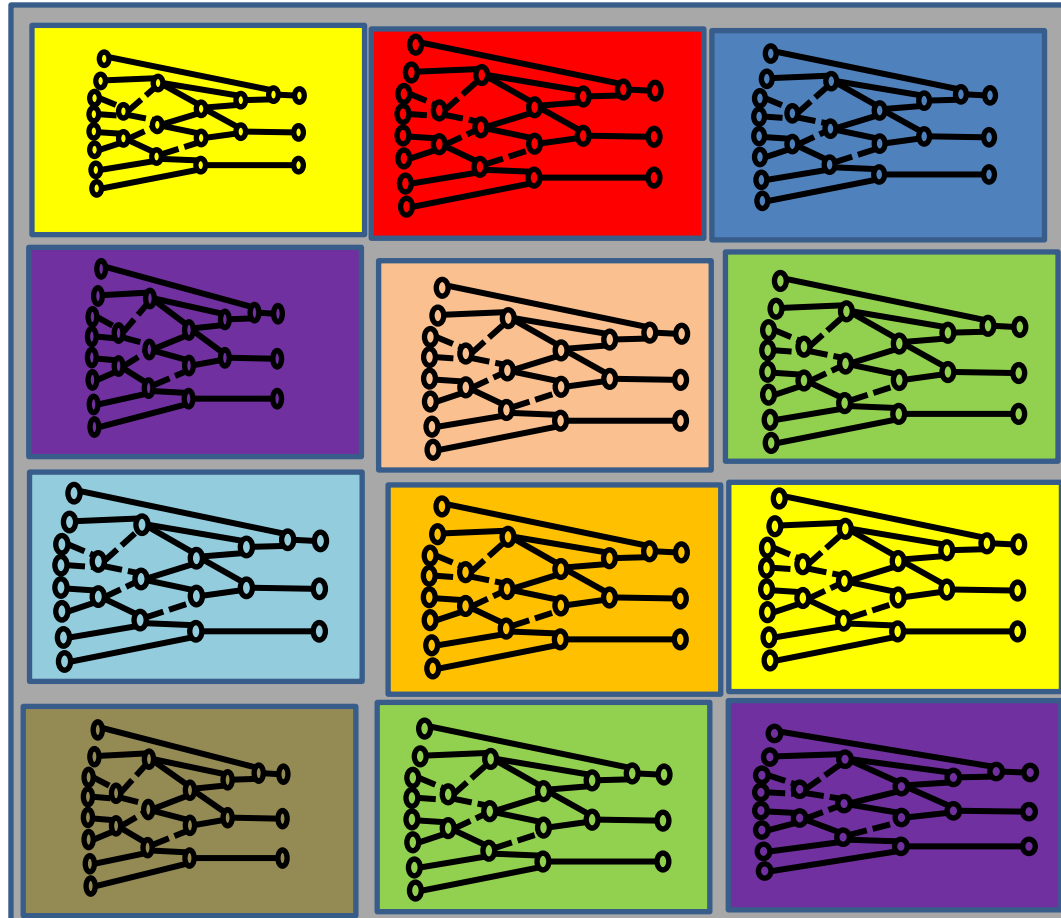

Step 5: Physical Design of 1L-cuts

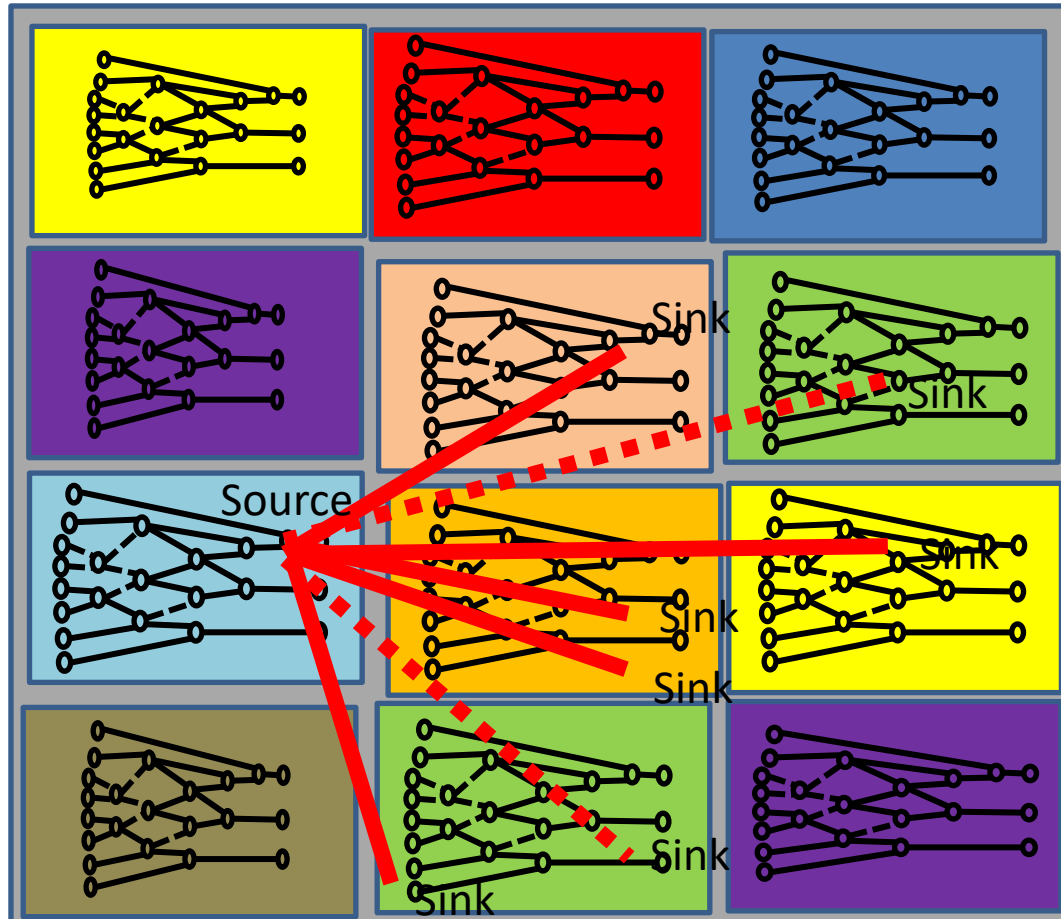

Step 6: Physical Design of 1L-cuts

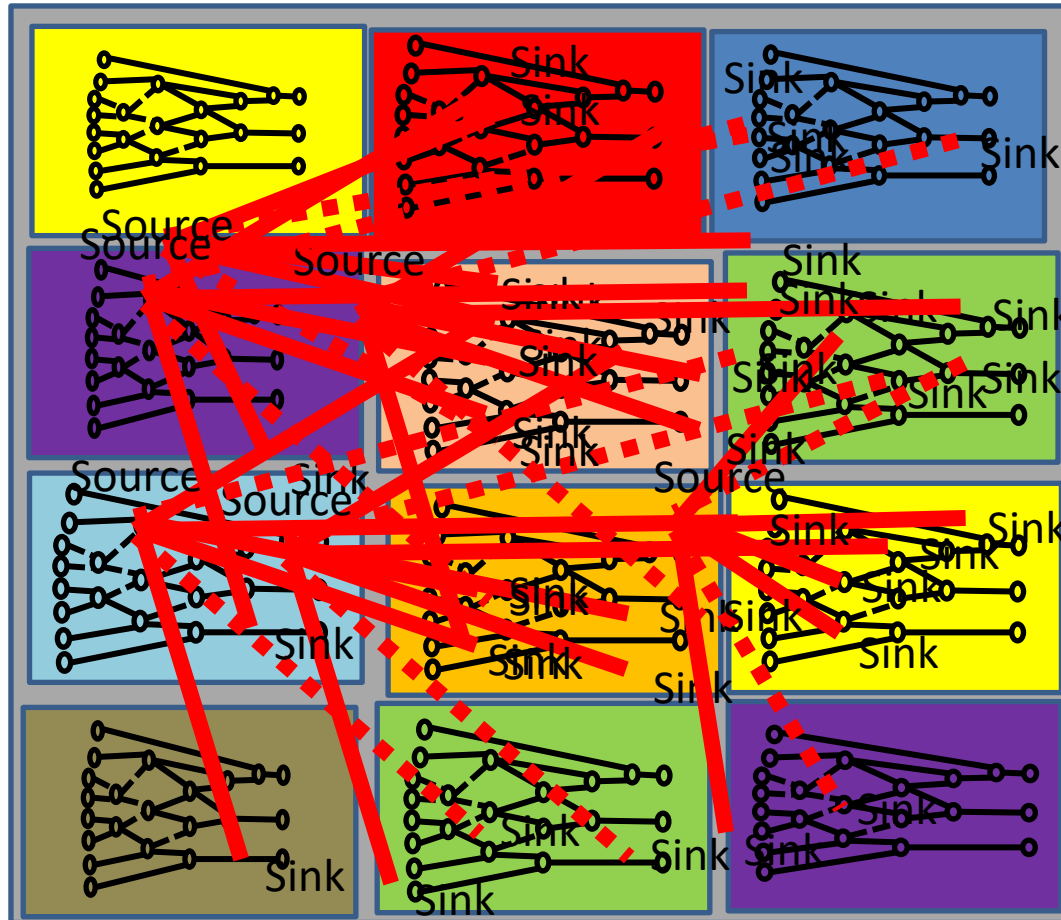

Step 6: Logic Synthesis of KL-cuts

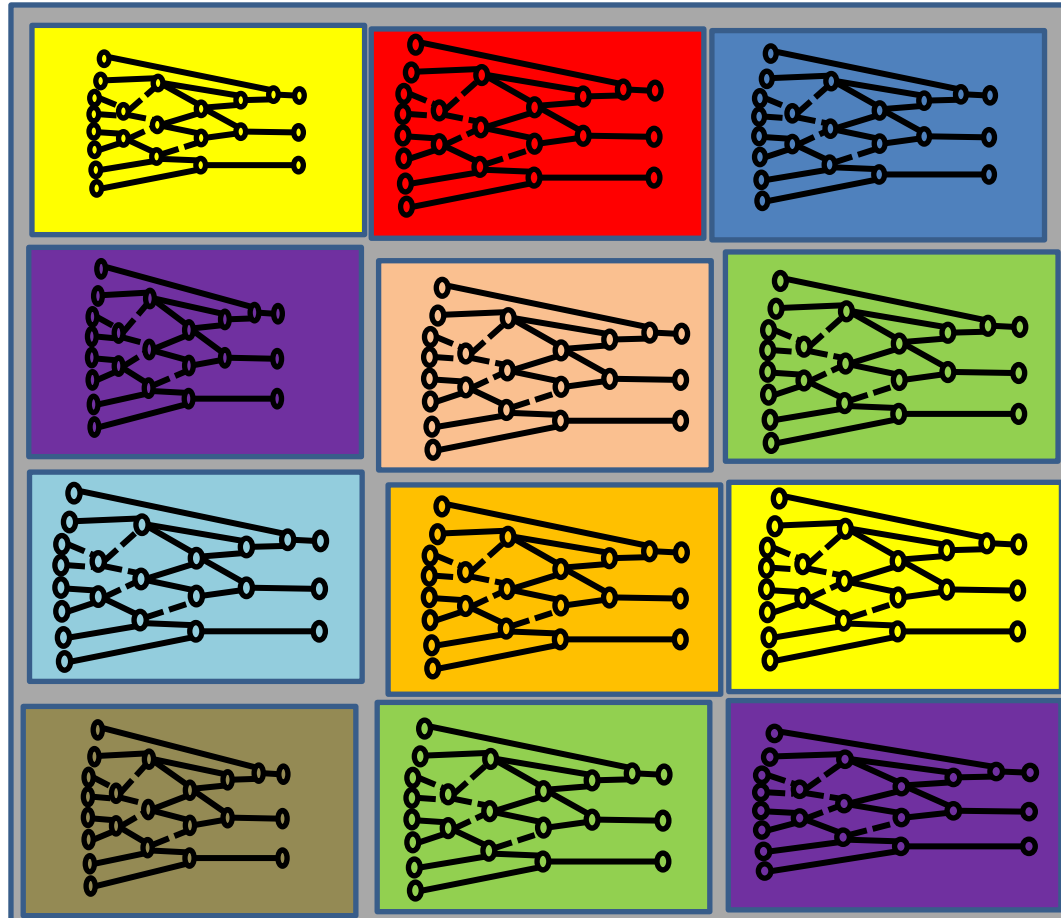

Step 6: Logic Synthesis of KL-cuts

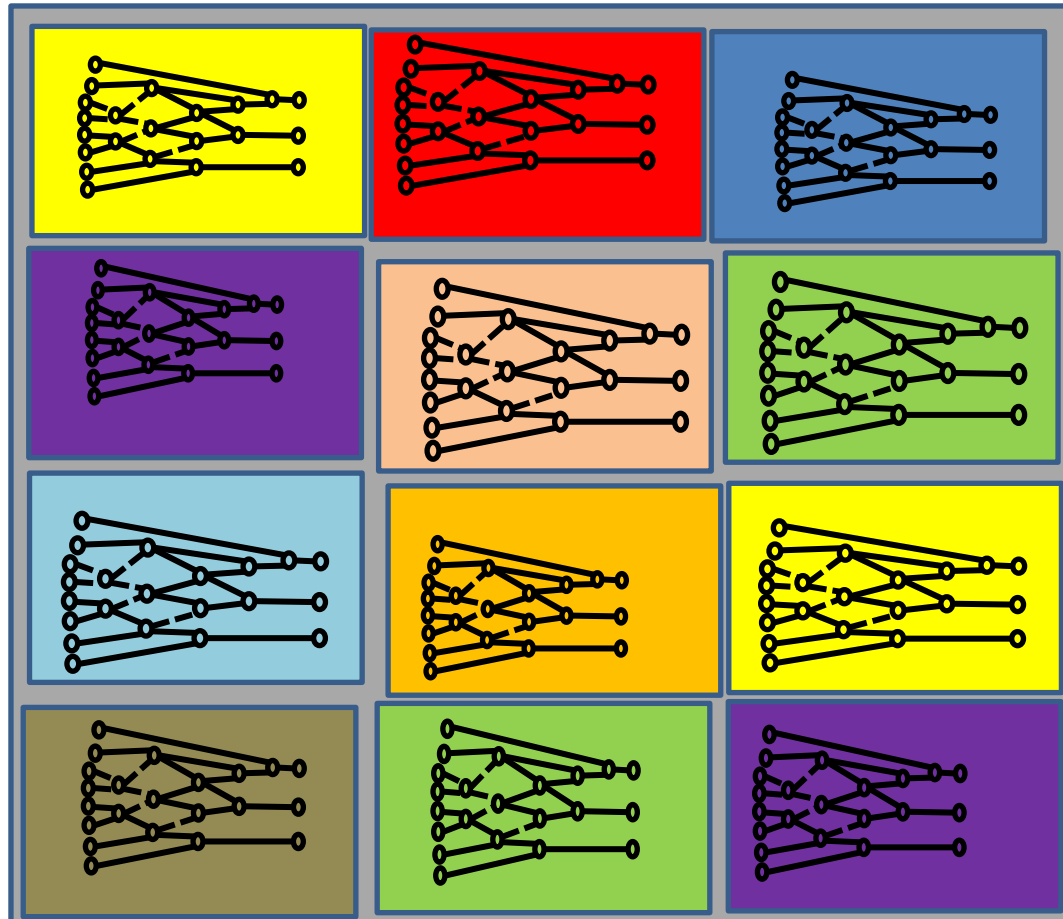

Step 7: Physical Design of KL-cuts

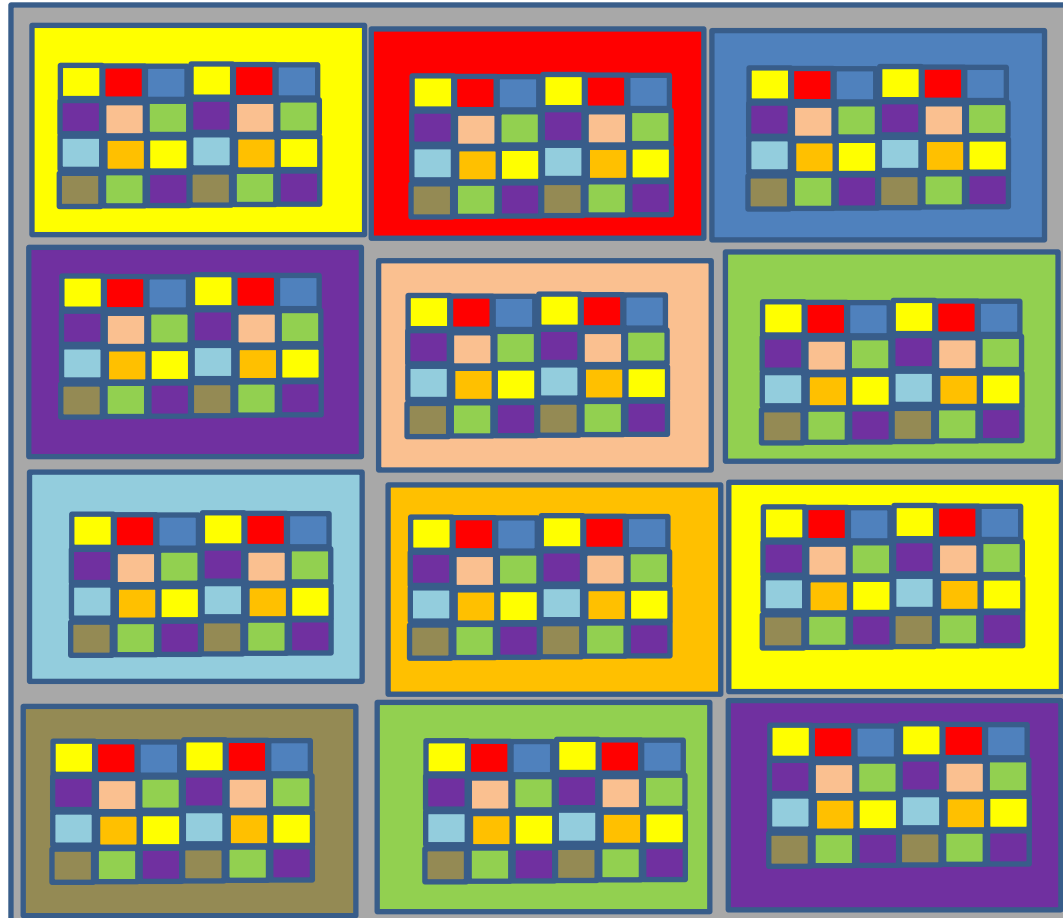

Step 8: Join Low Layers and Top Layers

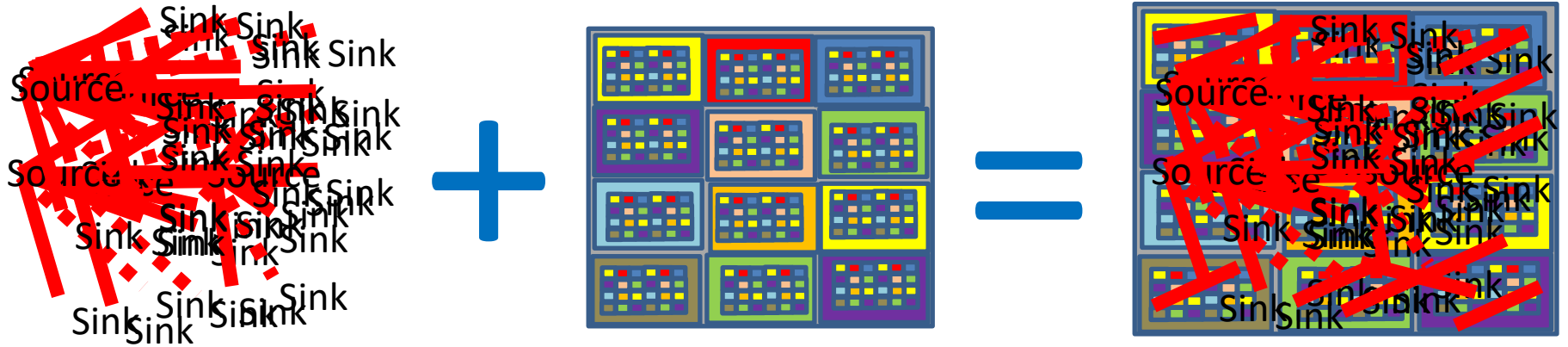

Conclusion: different inverters

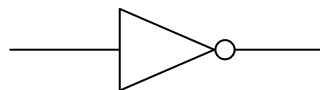

Conclusion: different inverters

- Logic computation inverter

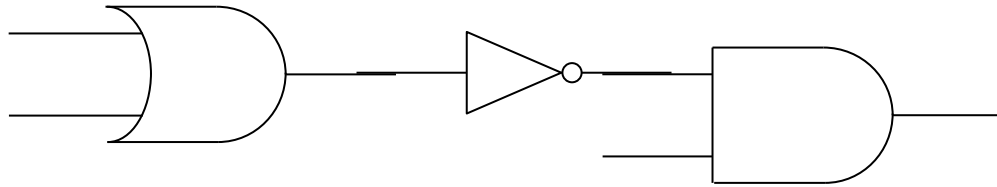

Conclusion: different inverters

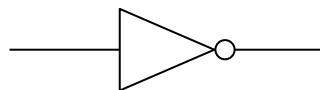

Conclusion: different inverters

- Signal distribution inverter

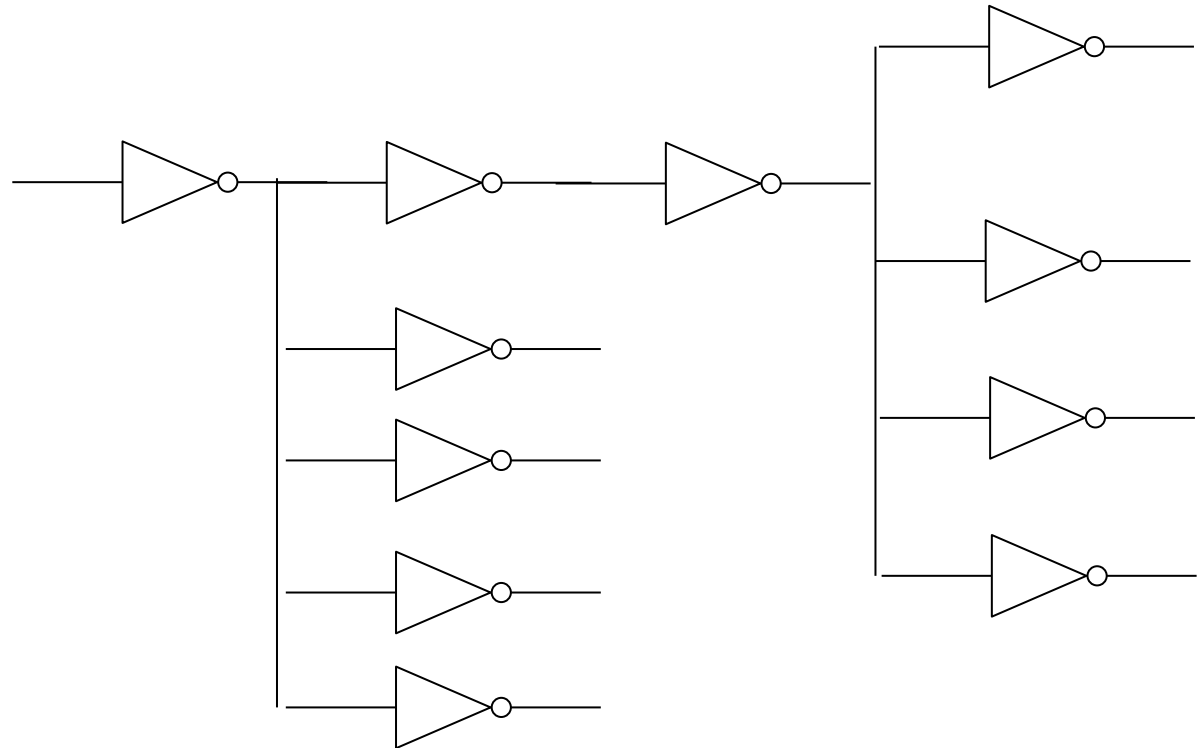

Conclusion

- The point is not try to mix
 - logic synthesis and
 - Physical design
- But to think about
 - Signal distribution and
 - Logic computation
- Signal distribution has elements of
 - Global routing
 - Clock distribution, but of signals instead of clocks